

Alpha 2.13.80.D24.N.B

codice/code 9300610

13
l/min.

3.4
gpm

80
bar

1160
psi



DATI PRESTAZIONALI / PERFORMANCES DATA

	Pressione/Pressure	bar	psi	
		80	1160	
	Giri/RPM	50 Hz	1450	
		60 Hz	1750	
	Portata/Flow rate	l/min	gpm	
		50 Hz	13	3.4
		60 Hz	16	4.2
	Motore/Engine	50 Hz	Hp	Kw
			2.7	2.0
		60 Hz	3.3	2.5
	Peso/Weight	Kg	lbs	
		7.5	16.5	
	Temperature	°C	°F	
		65	149	

CARATTERISTICHE / CHARACTERISTICS

- Particolari interni a contatto con fluidi: AISI316L
Internal components in contact with fluids: AISI316L
- Bassa rumorosità
Low noise
- Vibrazioni contenute
Low vibrations

TESTATA POMPA/ HEAD PUMP

Tecnopolimero + GF con inserti in ottone

Technopolymer + GF with brass inserts

CORPO POMPA/ BODY PUMP

Tecnopolimero per alte temperature

High temperature technopolymer

FLANGIA/ FLANGE

Alluminio con trattamento speciale anticorrosione

Aluminum with special anti-corrosion treatment

FLANGIATURA/FLANGE

MEC90 B3/B14 – attacco diretto su motore elettrico

MEC90 B3/B14 – direct connection to electric motor

GUARNIZIONI/SEALS

HP: NBR/Tela LP: Viton O-ring: Viton

PISTONI/PISTONS

N.5

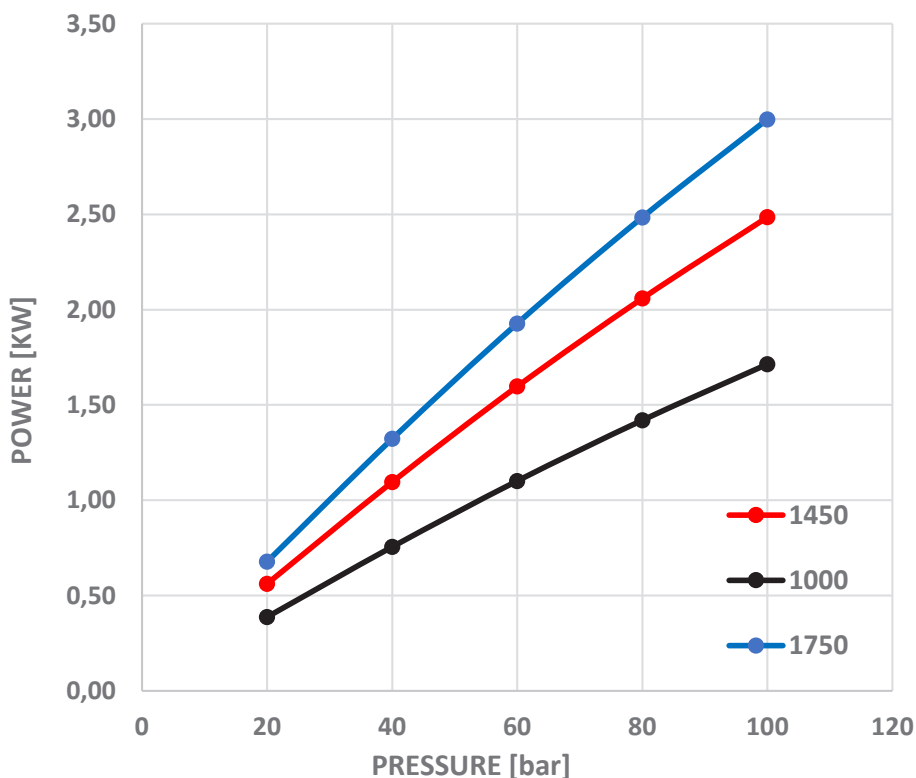

Disponibile anche in versione NEMA
Also available in NEMA version

Accuratezza media di portata: I valori di portata possono discostarsi +/-5% rispetto i valori di targa
Average flowrate accuracy: The flow rate values may vary by +/-5% compared to the production label values

miXtron
Dosing & High Pressure Pumps

Alpha 2.13.80.D24.N.B

codice/code 9300610

13
l/min.

3.4
gpm

80
bar

1160
psi

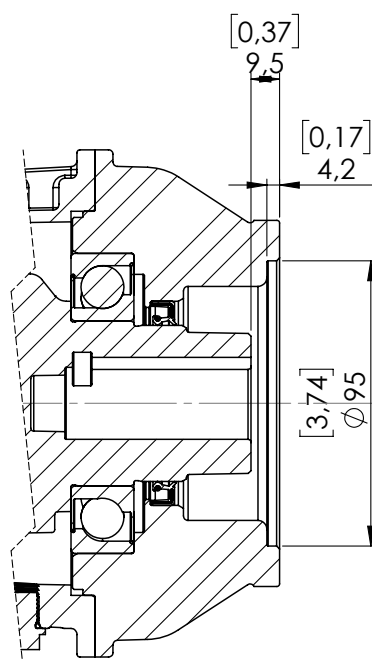
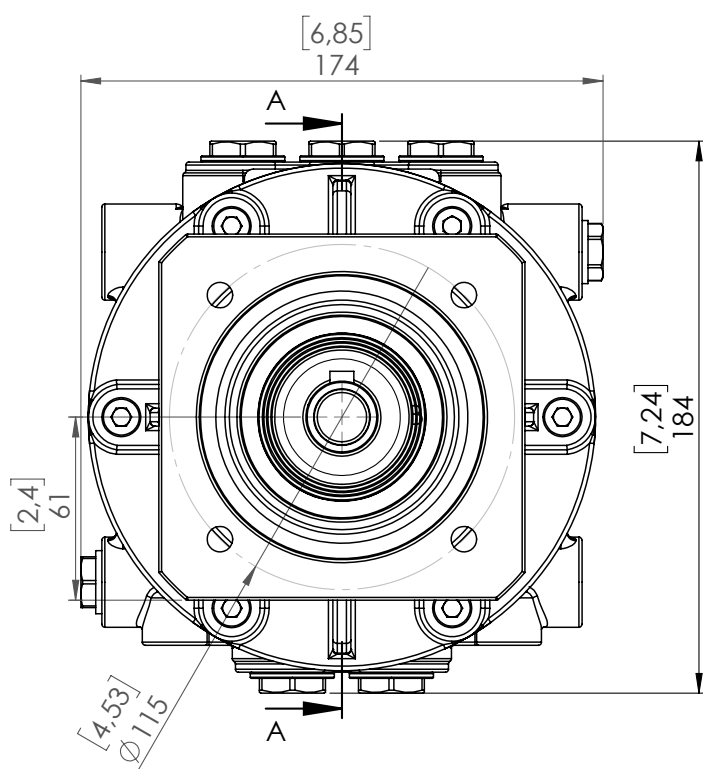
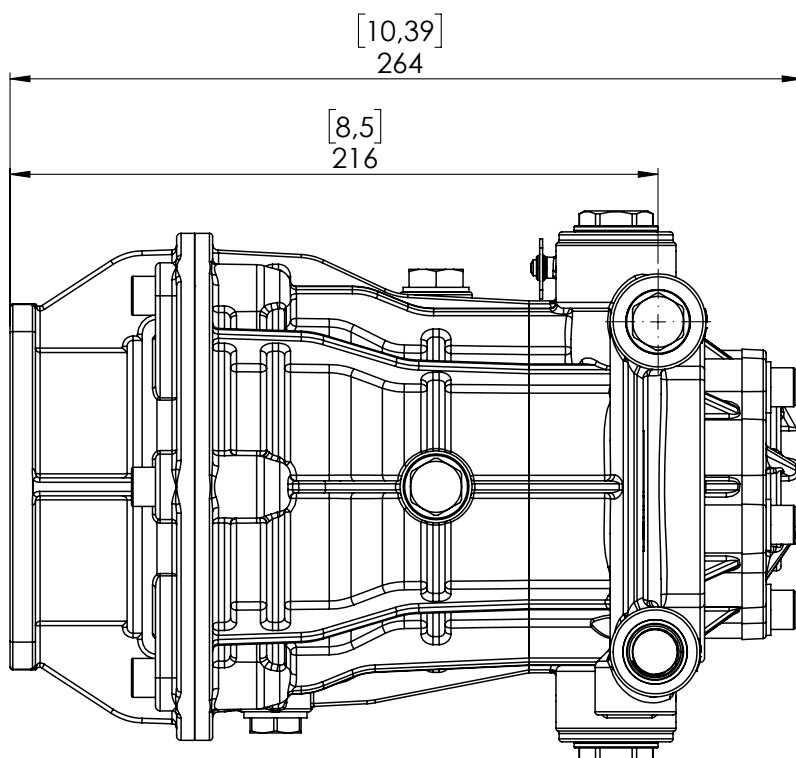
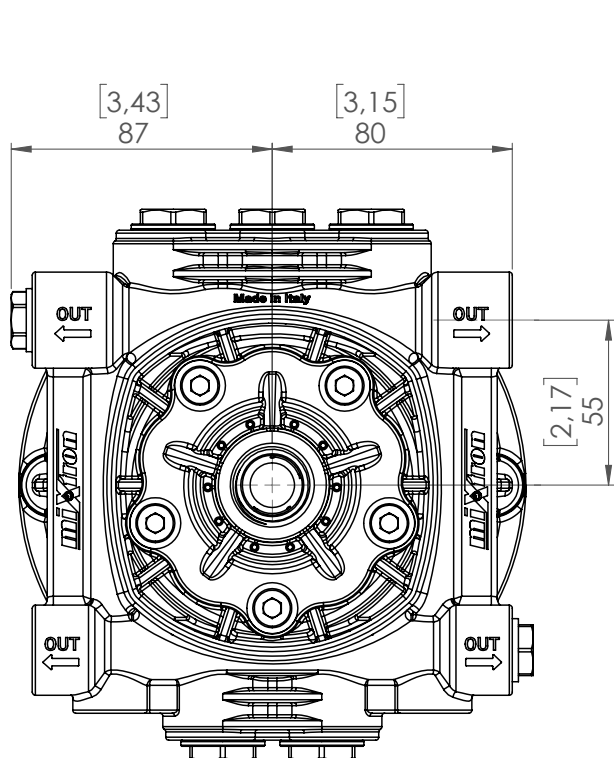

	INLET	G1/2" - F
	OUTLET	G3/8" - F

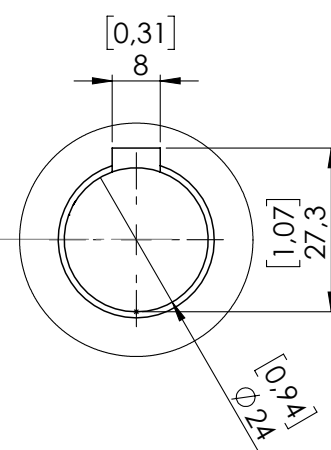

SEZIONE A-A