

MX.150.P110

1.500
l/h

6.60
gpm

1-10 %
dosing ratio



QUOTE (mm) / DIMENSIONS (in)

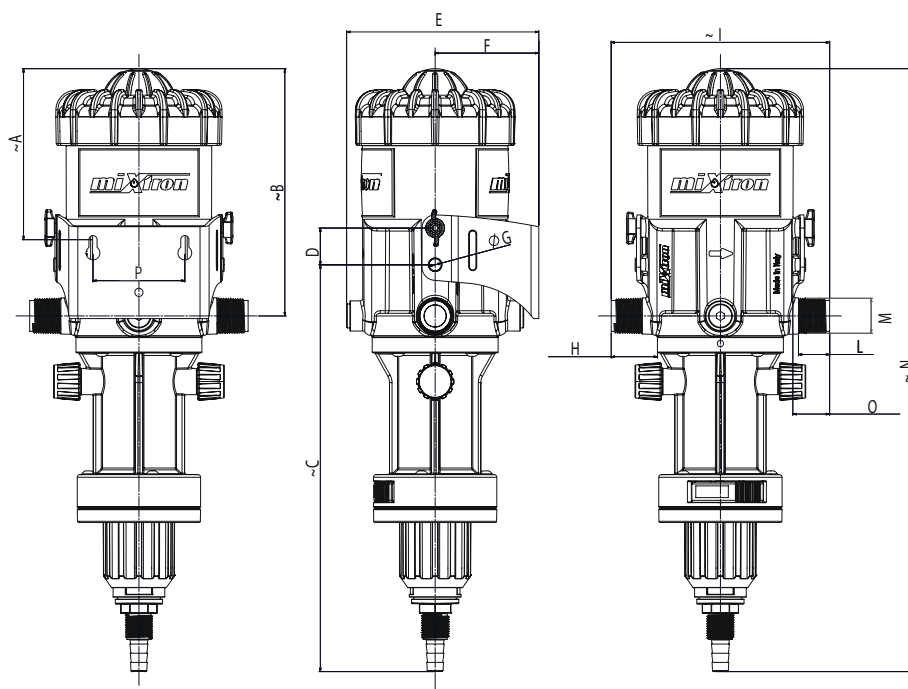

	mm	inches		mm	inches		mm	inches
A	130	5.12	F	79	3.11	M	3/4" BSPT	3/4" BSPT
B	188.5	7.42	G	Ø 10	Ø 0.39	N	460	18.11
C	310.1	12.21	H	35.3	1.390	O	28	1.1
D	28	1.1	I	166.5	6.56	P	70	2.76
E	146.5	5.77	L	23.8	0.94			

CARATTERISTICHE / CHARACTERISTICS

Dosaggio min/max % Min/Max dosing ratio %	1-10 %	Componenti metallici Metal components	AISI 316, Duplex
Min/Max rapp. dosaggio Min/Max dosing ratio	1:100 ; 1:10	Guarnizioni Seals	Viton, EPDM Viton EXT
Max portata motore Max water flow	1.500 l/h 6.60 gpm	Pressione di lavoro Operating pressure	0.3 - 6 bar 4.35 - 87 psi
Min portata motore Min water flow	10 l/h 0.05 gpm	Massima pressione statica Max static pressure	10 bar 145 psi
Componenti plastici Plastic components	POM, PP, HDPE, PA12	Temperatura Temperature	5 - 40° C 41- 104° F

miXtron
Dosing & High Pressure Pumps

Accuratezza media di dosaggio: +/- 5% - Ripetibilità media: +/-3% (dipendente dal modello e dalle condizioni operative, e dalla manutenzione regolare del prodotto, con particolare attenzione alla tenuta di aspirazione da sostituirsi almeno annualmente, o con maggiore frequenza quando lo richiedano le condizioni di lavoro o la natura dell'additivo).

Average dosing accuracy: +/- 5% - Average repeatability: +/-3% (depending on models and operating conditions and on appropriate maintenance of the product, in particular suction seal to be replaced at least yearly or more often when conditions or nature of the additive require).

MX.150.P110

1.500
l/h

6.60
gpm

1-10 %
dosing ratio

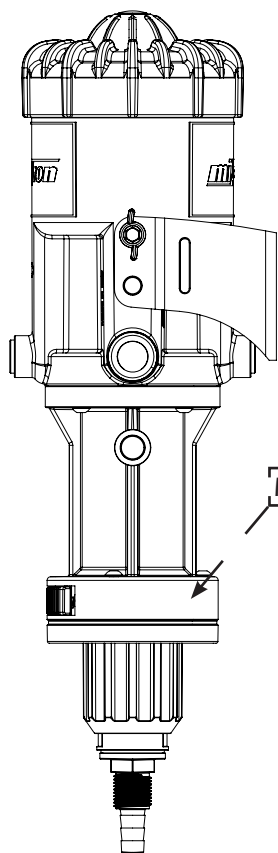

miXtron
Dosing & High Pressure Pumps

MX.150.P110.2.S.00.1.BSP.V

PRODUCT STANDARD CONFIGURATION AVAILABLE*

MX.150.P110.1.S.00.1.BSP.V
MX.150.P110.1.S.00.1.BSP.VX
MX.150.P110.1.S.00.1.BSP.EX
MX.150.P110.1.S.00.1.BSP.E
MX.150.P110.1.S.00.1.BSP.VP
MX.150.P110.1.S.OF.1.BSP.V
MX.150.P110.1.S.OF.1.BSP.VX
MX.150.P110.1.S.OF.1.BSP.EX
MX.150.P110.1.S.OF.1.BSP.E
MX.150.P110.1.S.OF.1.BSP.VP

ITA	MX	150	P110	1	*	**	1	BSP	*
modello									
max. portata acqua									
rapporto di dosaggio									
materiale pompa: POM									
iniezione additivo: S = iniezione interna B = iniezione esterna									
opzioni coperchio: 00 = valvola spurgo aria OF = valvola ON/OFF									
materiale corpo motore: POM									
filettature di collegamento									
guarnizioni: V = Viton VX = Viton+Viton EXT VP = Viton Premium E = Epdm EX = Epdm+Viton EXT									

GB	MX	150	P110	1	*	**	1	BSP	*
model									
max. water flow									
dosing ratio									
pump material: POM									
additive injection: S = internal injection B = external injection									
cover option: 00 = air bleed valve OF = ON/OFF valve									
motor housing material: POM									
connecting threads									
seals: V = Viton VX = Viton+Viton EXT VP = Viton Premium E = Epdm EX = Epdm+Viton EXT									

*For any request on dosers that are not found in the standard configurations, call us. We will solve your every need.